

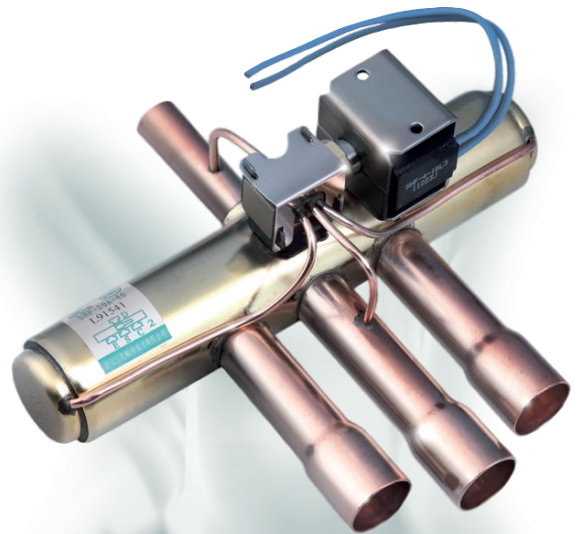

4 Way Reversing Valve

SHF series four-way reversing valves are applicable for heat pump systems such as central, unitary and room air conditioners to realize switching between cooling mode and heating mode by changing the flow path of refrigerant.



FEATURES

- WIDE APPLICATION RANGE
- SUITABLE FOR COOLING CAPACITIES FROM 3.6 TO 420KW (R410A, CONDITION 2)
- SEVERAL DESIGNS AVAILABLE

GENERAL SPECIFICATION

- Applicable for all common HCFC and HFC refrigerants such as: R22, R134a, R404A, R407C, R410A, R507
- Medium temperature TS min./max.: -30°C / +135°C (*)
- Ambient temperature min./max.: -30°C / +50°C
- Relative humidity: 0 to 95% RH
- Max. operating pressure PS \geq 4.5 MPa (45 bar)
- Installation position:
 - Coil upwards or with body axis in horizontal alignment
 - Flow direction according to installation instruction
- Certifications: UL/CSA** and declaration according to LVD or PED

* SHF-50-911-D2: TS min./max. : -30°C / +120°C
 ** SHF(L)-4H to SHF-50 valves, coil selection on request

NOMINAL OPERATING CONDITIONS

Nominal operating conditions	Condition 1:	Condition 2:
Condensing Temperature t_c	38°C	54,4°C
Evaporating Temperature t_o	5°C	7,2°C
Superheat Δt_{sh}	5K	5K
Subcooling Δt_{sc}	0K	5K

Notes for Capacity Selection Tables:

- 1) Pressure drop is valid for flow from $\emptyset C$ to $\emptyset S$ or from $\emptyset E$ to $\emptyset S$
- 2) R407C data based on dew point conditions



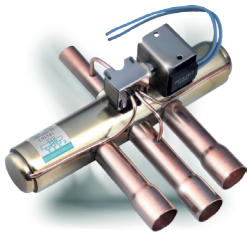

SANHUA SERIES SHF 4 Way Reversing Valve

GENERAL CHARACTERISTICS

Valve Model	Product Number (Multipack)	Ø Port [mm]	Kv [m ³ /h]	Connections ODF		MOP [MPa]	OPD		PED category
				ØD [inch]	ØE/S/C [inch]		Max. [MPa]	Min. [MPa]	
SHF(L)-3H-12U-51	10180944702	7,4	1,5	1/4	5/16	4,7	4	0,1	4,3
SHF(L)-4H-23U-51	10180944902	8	1,6	5/16	3/8	4,7	4	0,1	4,3
SHF(L)-7H-34U-51	10180945302	11,1	2,9	3/8	1/2	4,7	4	0,1	4,3
SHF(L)-7H-34-51	10180944002	11,1	2,9	3/8	1/2	4,7	4	0,1	4,3
SHF(L)-7H-35-51	10180945002	11,1	2,9	3/8	5/8	4,7	4	0,1	4,3
SHF(L)-11H-34U-51	10180947302	11,5	4,5	3/8	1/2	4,7	4	0,1	4,3
SHF(L)-11H-35U-51	10180942902	11,5	4,5	3/8	5/8	4,7	4	0,1	4,3
SHF(L)-11H-45D1-51	10180943002	11,5	4,5	1/2	5/8	4,7	4	0,1	4,3
SHF(L)-11H-46D1-51	10180944602	11,5	4,5	1/2	3/4	4,7	4	0,1	4,3
SHF-14A-46	10325030102	13,5	6,6	1/2	3/4	4,7	4	0,1	4,3
SHF-20D-46-02	10325020102	17,2	9,5	1/2	3/4	4,7	4	0,1	4,3
SHF-20D-47-02	10325030302	17,2	9,9	1/2	7/8	4,7	4	0,1	4,3
SHF-20D-57-02	10325032902	17,2	9,9	5/8	7/8	4,7	4	0,1	4,3
SHF-20D-67-02	10325039802	17,2	9,9	3/4	7/8	4,7	4	0,1	4,3
SHF-35B-47-04	10325033602	20	14,7	1/2	7/8	4,7	4	0,1	4,3
SHF-35B-57-04	10325035702	20	14,7	5/8	7/8	4,7	4	0,1	4,3
SHF-35B-59-04	10325039902	20	14,7	5/8	1 1/8	4,7	4	0,1	4,3
SHF-35B-67-04	10325031002	20	14,7	3/4	7/8	4,7	4	0,1	4,3
SHF-35B-69-04	10325035802	20,9	14,7	3/4	1 1/8	4,7	4	0,1	4,3
SHF-35B-79-04	10325033002	20,9	14,7	7/8	1 1/8	4,7	4	0,1	4,3
SHF-50A-79	10325030002	22,8	18,3	7/8	1 1/8	4,5	4	0,1	4,3
SHF-50-911D2	10325011602	25,6	18,5	1 1/8	1 3/8	4,7	4	0,1	I
SHF(L)-70-810	10325030202	28,6	28,5	1	1 1/4	4,5	4	0,15	4,3
SHF(L)-70-810-01	10325033102	28,6	28,5	1	1 1/4	4,5	4	0,15	4,3
SHF(L)-70-911	10325038302	28,6	28,5	1 1/8	1 3/8	4,5	4	0,15	I
SHF(L)-70-911-01	10325038302	28,6	28,5	1 1/8	1 3/8	4,5	4	0,15	I
SHF(L)-70-913-05	10325039502	28,6	28,5	1 1/8	1 5/8	4,5	4	0,15	I
SHF(L)-70-913-03	10325039702	28,6	28,5	1 1/8	1 5/8	4,5	4	0,15	I
SHF(L)-100-911	10325037902	34,8	40,5	1 1/8	1 3/8	4,5	4	0,15	I

DS-SHF-EN-R1706 Copyright © SANHUA 2018 Subject to change without notice



CHILLING IDEAS WORLDWIDE

SANHUA INTERNATIONAL EUROPE
sanhuaeurope.com

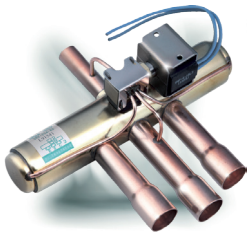

SANHUA SERIES SHF 4 Way Reversing Valve

GENERAL CHARACTERISTICS

Valve Model	Product Number (Multipack)	Ø Port [mm]	Kv [m ³ /h]	Connections ODF		MOP [MPa]	OPD		PED category
				ØD [inch]	ØE/S/C [inch]		Max. [MPa]	Min. [MPa]	
SHF(L)-100-911-01	10325038002	34,8	40,5	1 1/8	1 3/8	4,5	4	0,15	I
SHF(L)-100-913	10325033702	34,8	40,5	1 1/8	1 5/8	4,5	4	0,15	I
SHF(L)-100-913-01	10325034702	34,8	40,5	1 1/8	1 5/8	4,5	4	0,15	I
SHF(L)-100-1012	10325027102	34,8	40,5	1 1/4	1 1/2	4,5	4	0,15	I
SHF(L)-100-1012-01	10325033202	34,8	40,5	1 1/4	1 1/2	4,5	4	0,15	I
SHF(L)-100-1013	10325035502	34,8	40,5	1 1/4	1 5/8	4,5	4	0,15	I
SHF(L)-100-1013-01	10325038902	34,8	40,5	1 1/4	1 5/8	4,5	4	0,15	I
SHF(L)-140-1113	10325038102	41	58,4	1 3/8	1 5/8	4,5	4	0,15	I
SHF(L)-140-1213	10325038602	41	58,4	1 1/2	1 5/8	4,5	4	0,15	I
SHF(L)-140-1214	10180940402	41	58,4	1 1/2	1 3/4	4,5	4	0,15	I
SHF(L)-140-1313	10325034102	41	58,4	1 5/8	1 5/8	4,5	4	0,15	I
SHF(L)-175-1217	10325030402	46,4	70,5	1 1/2	2 1/8	4,5	4	0,15	I
SHF(L)-175-1317	10325034002	46,4	70,5	1 5/8	2 1/8	4,5	4	0,15	I
SHF(L)-210-1321	10325030502	50	84,4	1 5/8	2 5/8	4,5	4	0,15	I
SHF(L)-350-1721	10325043302	59	138,4	2 1/8	2 5/8	4,5	4	0,30	I
SHF(L)-420-2125	10325043602	69	177	2 5/8	3 1/8	4,5	4	0,30	I



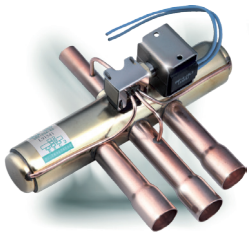

SANHUA SERIES SHF 4 Way Reversing Valve

CAPACITY SELECTION TABLE

Valve Model	Product Number (Multipack)	Nominal Capacity (condition 1)							
		R407C ²⁾		R410A		R134a		R404A / R507	
		$\Delta P:$ 0,1 bar	$\Delta P:$ 0,2 bar	$\Delta P:$ 0,1 bar	$\Delta P:$ 0,2 bar	$\Delta P:$ 0,1 bar	$\Delta P:$ 0,2 bar	$\Delta P:$ 0,1 bar	$\Delta P:$ 0,2 bar
		[kW]	[kW]	[kW]	[kW]	[kW]	[kW]	[kW]	[kW]
SHF(L)-3H-12U-51	10180944702	3,3	4,7	4,0	5,7	2,6	3,7	2,9	4,0
SHF(L)-4H-23U-51	10180944902	3,6	5,0	4,3	6,1	2,8	4,0	3,1	4,3
SHF(L)-7H-34U-51	10180945302	6,5	9,1	7,8	11,0	5,1	7,2	5,5	7,8
SHF(L)-7H-34-51	10180944002	6,5	9,1	7,8	11,0	5,1	7,2	5,5	7,8
SHF(L)-7H-35-51	10180945002	6,5	9,1	7,8	11,0	5,1	7,2	5,5	7,8
SHF(L)-11H-34U-51	10180947302	10,0	14,2	12,1	17,1	7,9	11,1	8,6	12,1
SHF(L)-11H-35U-51	10180942902	10,0	14,2	12,1	17,1	7,9	11,1	8,6	12,1
SHF(L)-11H-45D1-51	10180943002	10,0	14,2	12,1	17,1	7,9	11,1	8,6	12,1
SHF(L)-11H-46D1-51	10180944602	10,0	14,2	12,1	17,1	7,9	11,1	8,6	12,1
SHF-14A-46	10325030102	14,7	20,8	17,7	25,1	11,5	16,3	12,6	17,8
SHF-20D-46-02	10325020102	21,2	29,9	25,5	36,1	16,6	23,5	18,1	25,6
SHF-20D-47-02	10325030302	22,1	31,2	26,6	37,7	17,3	24,5	18,9	26,7
SHF-20D-57-02	10325032902	22,1	31,2	26,6	37,7	17,3	24,5	18,9	26,7
SHF-20D-67-02	10325039802	22,1	31,2	26,6	37,7	17,3	24,5	18,9	26,7
SHF-35B-47-04	10325033602	32,7	46,3	39,5	55,9	25,7	36,3	28,1	39,7
SHF-35B-57-04	10325035702	32,7	46,3	39,5	55,9	25,7	36,3	28,1	39,7
SHF-35B-59-04	10325039902	32,7	46,3	39,5	55,9	25,7	36,3	28,1	39,7
SHF-35B-67-04	10325031002	32,7	46,3	39,5	55,9	25,7	36,3	28,1	39,7
SHF-35B-69-04	10325035802	32,7	46,3	39,5	55,9	25,7	36,3	28,1	39,7
SHF-35B-79-04	10325033002	32,7	46,3	39,5	55,9	25,7	36,3	28,1	39,7
SHF-50A-79	10325030002	40,8	57,7	49,2	69,6	32,0	45,2	34,9	49,4
SHF-50-911D2	10325011602	41,2	58,3	49,8	70,4	32,3	45,7	35,3	49,9
SHF(L)-70-810	10325030201	63,5	89,8	76,6	108,4	49,8	70,4	54,4	76,9
SHF(L)-70-810-01	10325033101	63,5	89,8	76,6	108,4	49,8	70,4	54,4	76,9
SHF(L)-70-911	10325038301	63,5	89,8	76,6	108,4	49,8	70,4	54,4	76,9
SHF(L)-70-911-01	10325038301	63,5	89,8	76,6	108,4	49,8	70,4	54,4	76,9
SHF(L)-70-913-05	10325039501	63,5	89,8	76,6	108,4	49,8	70,4	54,4	76,9
SHF(L)-70-913-03	10325039701	63,5	89,8	76,6	108,4	49,8	70,4	54,4	76,9
SHF(L)-100-911	10325037901	90,2	127,6	108,9	154,0	70,8	100,1	77,3	109,3

DS-SHF-EN-R1706 Copyright © SANHUA 2018 Subject to change without notice



CHILLING IDEAS WORLDWIDE

SANHUA INTERNATIONAL EUROPE
sanhuaeurope.com

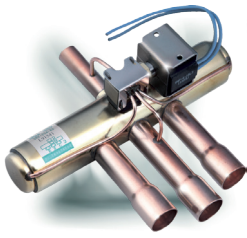

SANHUA SERIES SHF 4 Way Reversing Valve

CAPACITY SELECTION TABLE

Valve Model	Product Number (Multipack)	Nominal Capacity (condition 1)							
		R407C ²⁾		R410A		R134a		R404A / R507	
		$\Delta P:$ 0,1 bar	$\Delta P:$ 0,2 bar	$\Delta P:$ 0,1 bar	$\Delta P:$ 0,2 bar	$\Delta P:$ 0,1 bar	$\Delta P:$ 0,2 bar	$\Delta P:$ 0,1 bar	$\Delta P:$ 0,2 bar
		[kW]	[kW]	[kW]	[kW]	[kW]	[kW]	[kW]	[kW]
SHF(L)-100-911-01	10325038001	90,2	127,6	108,9	154,0	70,8	100,1	77,3	109,3
SHF(L)-100-913	10325033701	90,2	127,6	108,9	154,0	70,8	100,1	77,3	109,3
SHF(L)-100-913-01	10325034701	90,2	127,6	108,9	154,0	70,8	100,1	77,3	109,3
SHF(L)-100-1012	10325027101	90,2	127,6	108,9	154,0	70,8	100,1	77,3	109,3
SHF(L)-100-1012-01	10325033201	90,2	127,6	108,9	154,0	70,8	100,1	77,3	109,3
SHF(L)-100-1013	10325035501	90,2	127,6	108,9	154,0	70,8	100,1	77,3	109,3
SHF(L)-100-1013-01	10325038901	90,2	127,6	108,9	154,0	70,8	100,1	77,3	109,3
SHF(L)-140-1113	10325038101	130,1	184,0	157,1	222,1	102,0	144,3	111,5	157,6
SHF(L)-140-1213	10325038601	130,1	184,0	157,1	222,1	102,0	144,3	111,5	157,6
SHF(L)-140-1214	10180940401	130,1	184,0	157,1	222,1	102,0	144,3	111,5	157,6
SHF(L)-140-1313	10325034101	130,1	184,0	157,1	222,1	102,0	144,3	111,5	157,6
SHF(L)-175-1217	10325030401	157,0	222,1	189,6	268,1	123,2	174,2	134,6	190,3
SHF(L)-175-1317	10325034001	157,0	222,1	189,6	268,1	123,2	174,2	134,6	190,3
SHF(L)-210-1321	10325030501	188,0	265,9	227,0	321,0	147,5	208,6	161,1	227,8
SHF(L)-350-1721	10325043301	308,3	436,0	372,2	526,4	241,8	342,0	264,2	373,6
SHF(L)-420-2125	10325043601	394,3	557,6	476,0	673,2	309,3	437,4	337,8	477,8



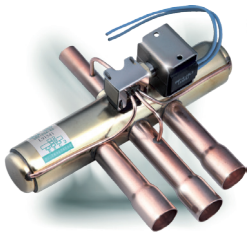

SANHUA SERIES SHF 4 Way Reversing Valve

CAPACITY SELECTION TABLE

Valve Model	Product Number	Nominal Capacity (condition 2)							
		R407C ²⁾		R410A		R134a		R404A / R507	
		$\Delta P:$ 0,1 bar	$\Delta P:$ 0,2 bar	$\Delta P:$ 0,1 bar	$\Delta P:$ 0,2 bar	$\Delta P:$ 0,1 bar	$\Delta P:$ 0,2 bar	$\Delta P:$ 0,1 bar	$\Delta P:$ 0,2 bar
		[kW]	[kW]	[kW]	[kW]	[kW]	[kW]	[kW]	[kW]
SHF(L)-3H-12U-51	10180944702	3,0	4,3	3,6	5,0	2,4	3,4	2,4	3,4
SHF(L)-4H-23U-51	10180944902	3,2	4,6	3,8	5,4	2,6	3,7	2,6	3,7
SHF(L)-7H-34U-51	10180945302	5,9	8,3	6,9	9,7	4,7	6,6	4,7	6,6
SHF(L)-7H-34-51	10180944002	5,9	8,3	6,9	9,7	4,7	6,6	4,7	6,6
SHF(L)-7H-35-51	10180945002	5,9	8,3	6,9	9,7	4,7	6,6	4,7	6,6
SHF(L)-11H-34U-51	10180947302	9,1	12,9	10,7	15,1	7,3	10,3	7,3	10,3
SHF(L)-11H-35U-51	10180942902	9,1	12,9	10,7	15,1	7,3	10,3	7,3	10,3
SHF(L)-11H-45D1-51	10180943002	9,1	12,9	10,7	15,1	7,3	10,3	7,3	10,3
SHF(L)-11H-46D1-51	10180944602	9,1	12,9	10,7	15,1	7,3	10,3	7,3	10,3
SHF-14A-46	10325030102	13,4	18,9	15,7	22,2	10,7	15,1	10,7	15,1
SHF-20D-46-02	10325020102	19,3	27,3	22,5	31,9	15,4	21,7	15,4	21,7
SHF-20D-47-02	10325030302	20,1	28,4	23,5	33,2	16,0	22,7	16,0	22,6
SHF-20D-57-02	10325032902	20,1	28,4	23,5	33,2	16,0	22,7	16,0	22,6
SHF-20D-67-02	10325039802	20,1	28,4	23,5	33,2	16,0	22,7	16,0	22,6
SHF-35B-47-04	10325033602	29,8	42,2	34,9	49,3	23,8	33,7	23,8	33,6
SHF-35B-57-04	10325035702	29,8	42,2	34,9	49,3	23,8	33,7	23,8	33,6
SHF-35B-59-04	10325039902	29,8	42,2	34,9	49,3	23,8	33,7	23,8	33,6
SHF-35B-67-04	10325031002	29,8	42,2	34,9	49,3	23,8	33,7	23,8	33,6
SHF-35B-69-04	10325035802	29,8	42,2	34,9	49,3	23,8	33,7	23,8	33,6
SHF-35B-79-04	10325033002	29,8	42,2	34,9	49,3	23,8	33,7	23,8	33,6
SHF-50A-79	10325030002	37,1	52,5	43,4	61,4	29,6	41,9	29,6	41,8
SHF-50-911D2	10325011602	37,5	53,1	43,9	62,1	29,9	42,4	29,9	42,3
SHF(L)-70-810	10325030201	57,8	81,8	67,6	95,7	46,1	65,2	46,1	65,2
SHF(L)-70-810-01	10325033101	57,8	81,8	67,6	95,7	46,1	65,2	46,1	65,2
SHF(L)-70-911	10325038301	57,8	81,8	67,6	95,7	46,1	65,2	46,1	65,2
SHF(L)-70-911-01	10325038301	57,8	81,8	67,6	95,7	46,1	65,2	46,1	65,2
SHF(L)-70-913-05	10325039501	57,8	81,8	67,6	95,7	46,1	65,2	46,1	65,2
SHF(L)-70-913-03	10325039701	57,8	81,8	67,6	95,7	46,1	65,2	46,1	65,2
SHF(L)-100-911	10325037901	82,2	116,2	96,1	136,0	65,6	92,7	65,5	92,6

DS-SHF-EN-R1706
Copyright © SANHUA 2018 Subject to change without notice



CHILLING IDEAS WORLDWIDE

SANHUA INTERNATIONAL EUROPE
sanhuaeurope.com

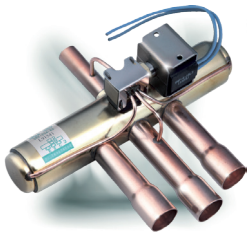

SANHUA SERIES SHF 4 Way Reversing Valve

CAPACITY SELECTION TABLE

Valve Model	Product Number	Nominal Capacity (condition 2)							
		R407C ²⁾		R410A		R134a		R404A / R507	
		$\Delta P:$ 0,1 bar	$\Delta P:$ 0,2 bar	$\Delta P:$ 0,1 bar	$\Delta P:$ 0,2 bar	$\Delta P:$ 0,1 bar	$\Delta P:$ 0,2 bar	$\Delta P:$ 0,1 bar	$\Delta P:$ 0,2 bar
		[kW]	[kW]	[kW]	[kW]	[kW]	[kW]	[kW]	[kW]
SHF(L)-100-911-01	10325038001	82,2	116,2	96,1	136,0	65,6	92,7	65,5	92,6
SHF(L)-100-913	10325033701	82,2	116,2	96,1	136,0	65,6	92,7	65,5	92,6
SHF(L)-100-913-01	10325034701	82,2	116,2	96,1	136,0	65,6	92,7	65,5	92,6
SHF(L)-100-1012	10325027101	82,2	116,2	96,1	136,0	65,6	92,7	65,5	92,6
SHF(L)-100-1012-01	10325033201	82,2	116,2	96,1	136,0	65,6	92,7	65,5	92,6
SHF(L)-100-1013	10325035501	82,2	116,2	96,1	136,0	65,6	92,7	65,5	92,6
SHF(L)-100-1013-01	10325038901	82,2	116,2	96,1	136,0	65,6	92,7	65,5	92,6
SHF(L)-140-1113	10325038101	118,5	167,5	138,6	196,0	94,5	133,7	94,4	133,5
SHF(L)-140-1213	10325038601	118,5	167,5	138,6	196,0	94,5	133,7	94,4	133,5
SHF(L)-140-1214	10180940401	118,5	167,5	138,6	196,0	94,5	133,7	94,4	133,5
SHF(L)-140-1313	10325034101	118,5	167,5	138,6	196,0	94,5	133,7	94,4	133,5
SHF(L)-175-1217	10325030401	143,0	202,2	167,3	236,7	114,1	161,4	114,0	161,2
SHF(L)-175-1317	10325034001	143,0	202,2	167,3	236,7	114,1	161,4	114,0	161,2
SHF(L)-210-1321	10325030501	171,2	242,1	200,3	283,3	136,6	193,2	136,5	193,0
SHF(L)-350-1721	10325043301	280,7	397,0	328,5	464,6	224,1	316,9	223,8	316,4
SHF(L)-420-2125	10325043601	359,0	507,8	420,1	594,2	286,5	405,2	286,2	404,7



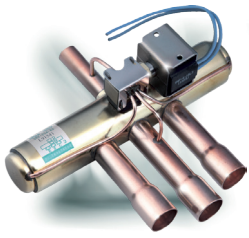

SANHUA *SERIES SHF* 4 Way Reversing Valve

DIMENSIONS - VALVES

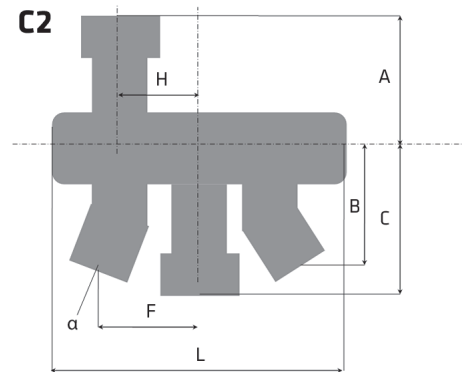
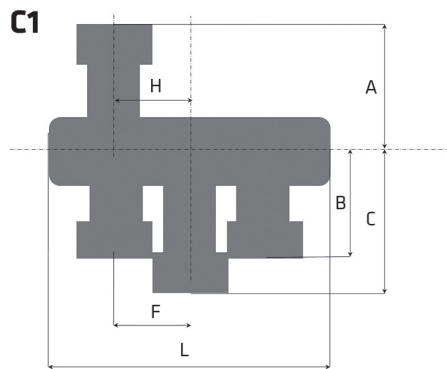
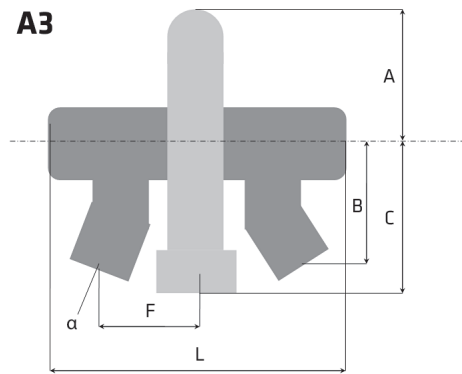
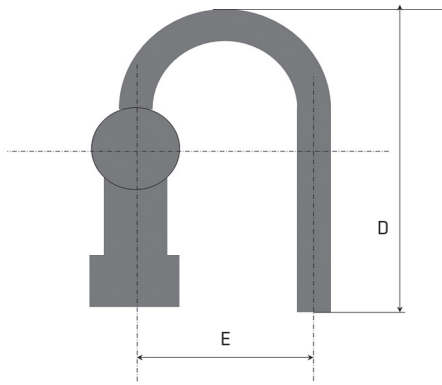
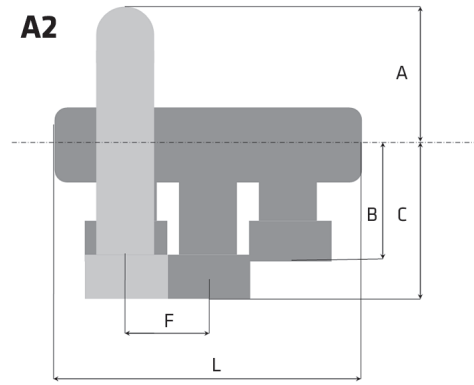
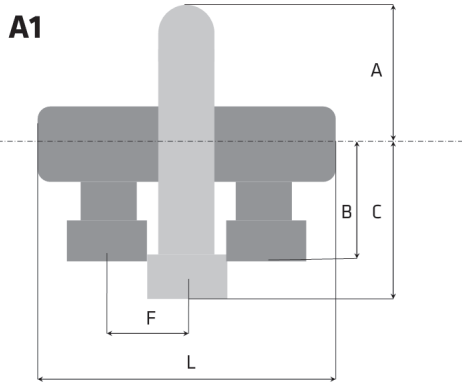

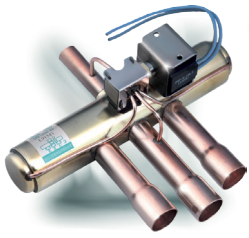

SANHUA *SERIES SHF* 4 Way Reversing Valve

DIMENSIONS - VALVES

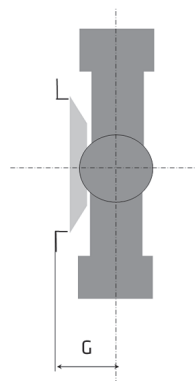
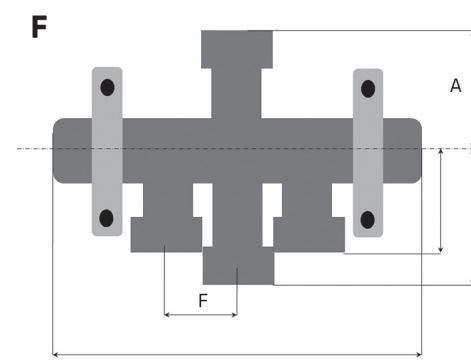
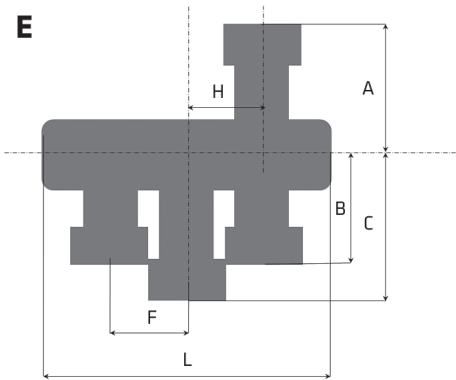
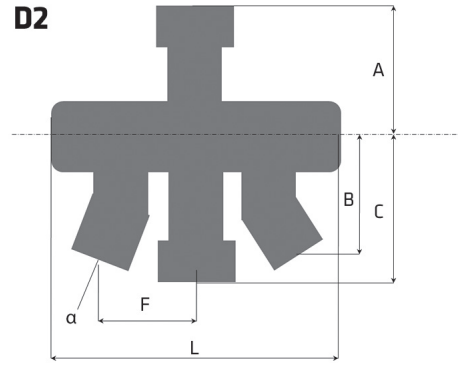
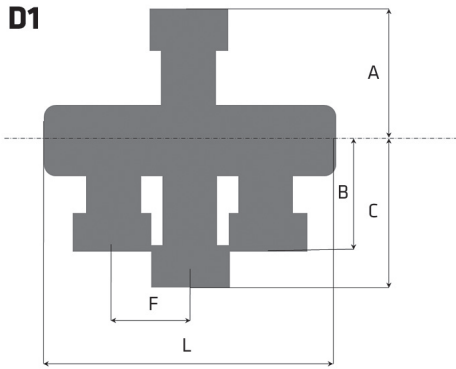

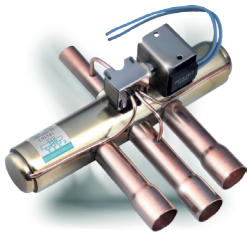

SANHUA SERIES SHF 4 Way Reversing Valve

DIMENSIONS - VALVES

Valve Model	Product Number	Valve Style	L	A	B	C	D	E	F	G	H	Angle α	Weight
			[mm]	[mm]	[mm]	[mm]	[mm]	[mm]	[mm]	[mm]	[mm]	[mm]	[°]
SHF(L)-3H-12U-51	10180944702	A1	88,2	38,5	38	50	88,5	43	11	-	-	0	0,2
SHF(L)-4H-23U-51	10180944902	A1	94,4	43	50	62	105	43	12	-	-	0	0,2
SHF(L)-7H-34U-51	10180945302	A1	113	52	59	71	119	52	16	-	-	0	0,3
SHF(L)-7H-34-51	10180944002	D1	113	52	59	71	-	-	16	-	-	0	0,3
SHF(L)-7H-35-51	10180945002	D2	113	52	57	72	-	-	23,5	-	16	0	0,3
SHF(L)-11H-34U-51	10180947302	A1	115,5	51	59	71	119	52	16	-	-	0	0,3
SHF(L)-11H-35U-51	10180942902	A3	115,5	51	57	71	119	52	23,5	-	-	15	0,3
SHF(L)-11H-45D1-51	10180943002	C2	117	52	62	87	-	-	25	-	16	15	0,32
SHF(L)-11H-46D1-51	10180944602	C2	117	52	82	87	-	-	32,5	-	16	20	0,35
SHF-14A-46	10325030102	D1	163	67	83	95	-	-	23,8	-	-	0	0,72
SHF-20D-46-02	10325020102	D1	183,6	67	83	95	-	-	28,6	-	-	0	0,75
SHF-20D-47-02	10325030302	D1	183,6	67	83	95	-	-	28,6	-	-	0	0,75
SHF-20D-57-02	10325032902	D1	183,6	67	83	95	-	-	28,6	-	-	0	0,75
SHF-20D-67-02	10325039802	D1	183,6	67	83	95	-	-	28,6	-	-	0	0,75
SHF-35B-47-04	10325033602	D1	212,2	82	87	100	-	-	33	-	-	0	1,3
SHF-35B-57-04	10325035702	D1	212,2	82	87	100	-	-	33	-	-	0	1,3
SHF-35B-59-04	10325039902	D1	212,2	82	87	100	-	-	33	-	-	0	1,3
SHF-35B-67-04	10325031002	D1	212,2	82	87	100	-	-	33	-	-	0	1,3
SHF-35B-69-04	10325035802	D1	212,2	82	87	100	-	-	33	-	-	0	1,3
SHF-35B-79-04	10325033002	D1	212,2	82	87	100	-	-	33	-	-	0	1,3
SHF-50A-79	10325030002	D1	217	91	96	128	-	-	33	-	-	0	2,1
SHF-50-911D2	10325011602	E	269	97	149	174	-	-	41,3	-	41,3	0	2,1
SHF(L)-70-810	10325030201	D1	303	111	117	131	-	-	46	-	-	0	3
SHF(L)-70-810-01	10325033101	F	303	111	117	154	-	-	46	58	-	0	3
SHF(L)-70-911	10325038301	D1	303	111	117	154	-	-	46	-	-	0	3
SHF(L)-70-911-01	10325038301	F	321	111	117	131	-	-	49	58	-	0	3,5
SHF(L)-70-913-05	10325039501	D1	321	111	117	131	-	-	49	-	-	0	3,5
SHF(L)-70-913-03	10325039701	F	321	111	117	131	-	-	49	58	-	0	3,5
SHF(L)-100-911	10325037901	D1	321	111	117	131	-	-	49	-	-	0	3,5



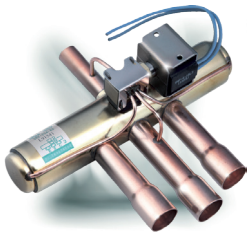

SANHUA SERIES SHF 4 Way Reversing Valve

DIMENSIONS - VALVES

Valve Model	Product Number	Valve Style	L	A	B	C	D	E	F	G	H	Angle α	Weight
			[mm]	[mm]	[mm]	[mm]	[mm]	[mm]	[mm]	[mm]	[mm]	[mm]	[°]
SHF(L)-100-911-01	10325038001	F	303	111	117	131	-	-	46	58	-	0	3
SHF(L)-100-913	10325033701	D1	303	111	117	154	-	-	46	-	-	0	3
SHF(L)-100-913-01	10325034701	F	303	111	117	154	-	-	46	58	-	0	3
SHF(L)-100-1012	10325027101	D1	321	111	117	131	-	-	49	-	-	0	3,5
SHF(L)-100-1012-01	10325033201	F	321	111	117	131	-	-	49	58	-	0	3,5
SHF(L)-100-1013	10325035501	D1	321	111	117	131	-	-	49	-	-	0	3,5
SHF(L)-100-1013-01	10325038901	F	321	111	117	131	-	-	49	58	-	0	3,5
SHF(L)-140-1113	10325038101	F	390	135,6	148,7	168,7	-	-	58	63	-	0	7,2
SHF(L)-140-1213	10325038601	F	390	135,6	148,7	168,7	-	-	58	63	-	0	7,2
SHF(L)-140-1214	10180940401	F	390	135,6	148,7	168,7	-	-	58	63	-	0	7,2
SHF(L)-140-1313	10325034101	F	390	135,6	148,7	168,7	-	-	58	63	-	0	7,2
SHF(L)-175-1217	10325030401	F	390	135,6	148,7	198	-	-	58	63	-	0	7,6
SHF(L)-175-1317	10325034001	F	390	135,6	148,7	198	-	-	58	63	-	0	7,6
SHF(L)-210-1321	10325030501	F	452	135,6	148,7	198	-	-	71,5	63	-	0	8,7
SHF(L)-350-1721	10325043301	F	531	176,5	184	240	-	-	75	82,5	-	0	22
SHF(L)-420-2125	10325043601	F	611,7	176,5	184	240	-	-	93	82,5	-	0	26



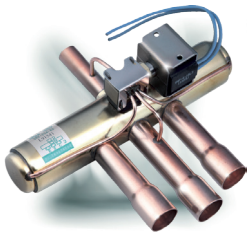

SANHUA SERIES SHF 4 Way Reversing Valve

COIL CHARACTERISTICS

Coil Model ¹⁾	Winding Code	Product Number	Electrical function / connection Type	Cable Length	Power Supply	Rated Voltage	Power Consumption			Protection class	Insulation class	Max. Op. Temp.
							AC 50Hz	AC 60Hz	DC			
				[mm]	[-]	[V]	[W]	[W]	[W]	[-]	[-]	[°C]
SQ-A25 22G-00 0001	SHF-4-10L3	10805029102	Lead Wires	500	AC	220-240	4,5	3,5	-	IP54	B ²⁾	130
SQ-A25 200-00 0001	SHF-4-10L2	10805027002	Lead Wires	500	AC	200	4,5	3,5	-			
SQ-A25 100-00 0001	SHF-4-10L1	10805023602	Lead Wires	500	AC	100	4,5	3,5	-			
SQ-A25 11A-00 0001	SHF-4-10L4	10805150302	Lead Wires	500	AC	110-120	4,5	3,5	-			
SQ-A25 024-00 0001	SHF-4-10L5	10805227602	Lead Wires	500	AC	24	4,5	3,5	-			
SQ-A25 26H-00 0001	SHF-4-10L6	10805231902	Lead Wires	500	AC	265-277	4,5	3,5	-			
SQ-A25 22G-00 0870	SHF-4-10L3	10805240702	Lead Wires	1500	AC	220-240	4,5	3,5	-			
SQ-A25 11A-00 0840	SHF-4-10L4	10805240802	Lead Wires	1500	AC	110-120	4,5	3,5	-			
SQ-A25 024-00 0161	SHF-4-10L5	10805023002	Lead Wires	1500	AC	24	4,5	3,5	-			
SQ-A47 22G-00 0001	SHF-4-10FA5	10805263402	Spade (Faston) ³⁾	-	AC	220-240	6	5	-	IP00	F ³⁾	155
SQ-A47 220-00 0001	SHF-4-10FA1	10805273402	Spade (Faston) ³⁾	-	AC	220	6	5	-			
SQ-A47 11B-00 0001	SHF-4-10FA2	10805273302	Spade (Faston) ³⁾	-	AC	120	6	5	-			
SQ-A47 10A-00 0001	SHF-4-10FA3	10805268702	Spade (Faston) ³⁾	-	AC	100-110	6	5	-			
SQ-A47 024-00 0001	SHF-4-10FA4	10805263302	Spade (Faston) ³⁾	-	AC	24	6	5	-			
SQ-A47 26H-00 0001	SHF-4-10FA6	10805273502	Spade (Faston) ³⁾	-	AC	265-277	6	5	-			
SQ-D44 012-00 0001	SHF-4-10FA8	10805231802	Spade (Faston) ³⁾	-	DC	12	-	-	10			
SQ-D44 024-00 0001	SHF-4-10FA9	10805070102	Spade (Faston) ³⁾	-	DC	24	-	-	11			
SQ-A27 100-00 0001	-	10805063202	Bi-stable/ Lead W.	500	AC	100	18	18	-			
SQ-A27 200-00 0001	-	10805063802	Bi-stable/ Lead W.	500	AC	200	18	18	-			
SQ-A27 20K-00 0001	-	10805222902	Bi-stable/ Lead W.	500	AC	220-240	18	18	-			
SQ-D27 012-00 0001	-	10805069302	Bi-stable/ Lead W.	500	DC	12	-	-	20			

Note:

- 1) Every coil is applicable to all above specified valve models
- 2) Max ambient temperature up to + 50°C
- 3) Wire Harness for coil with Faston connector available as accessory



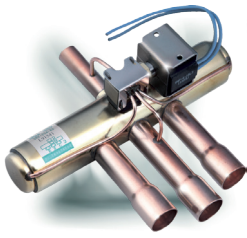

SANHUA SERIES SHF 4 Way Reversing Valve

ACCESSORY

Wire Harness		
Model	Product Number	Cable Length [mm]
SQ-000000-090028	20805136301	1200
SQ-000000-090029	20805149201	2000

DIMENSIONS - COILS

Coils with Lead Wires (SQ-A25 Series)

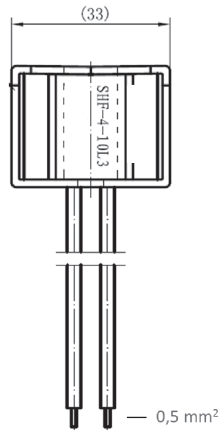
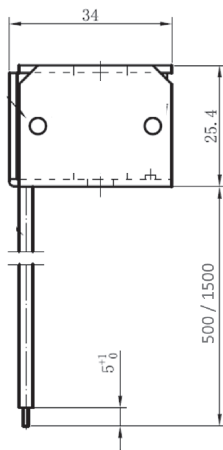

Bistable Coils (SQ-A/D27 Series)

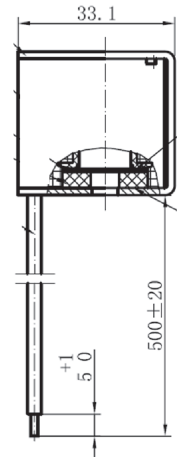
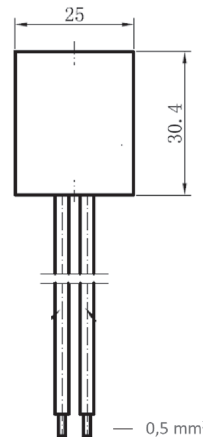

Coils with Spade Connections (SQ-A47 and SQ-D44 Series)

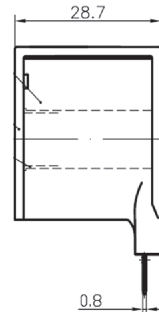
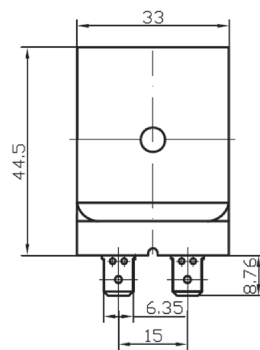

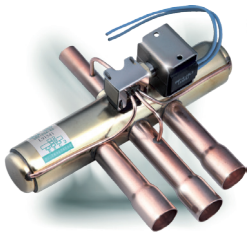

SANHUA SERIES SHF 4 Way Reversing Valve

DIMENSIONS - COILS

Wire Harness (SQ-000000-0900xx)

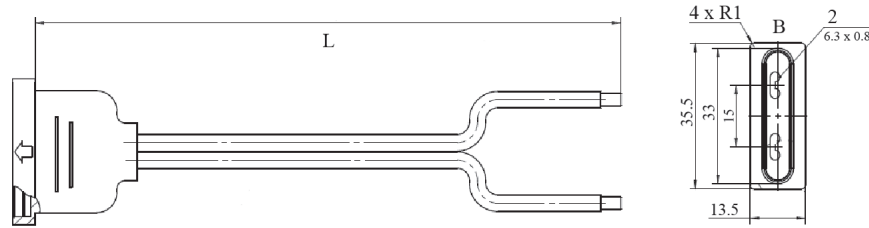

APPENDIX 1

Conversion Table old/new Product Numbers

Valve Model	Product Number OLD reference	Product Number NEW reference (Multipack)
SHF(L)-3H-12U-51	SHF-19007	10180944702
SHF(L)-4H-23U-51	SHF-19008	10180944902
SHF(L)-7H-34U-51	SHF-19020	10180945302
SHF(L)-7H-34-51	SHF-19021	10180944002
SHF(L)-7H-35-51	SHF-19011	10180945002
SHF(L)-11H-34U-51	SHF-19022	10180947302
SHF(L)-11H-35U-51	SHF-19013	10180942902
SHF(L)-11H-45D1-51	SHF-19014	10180943002
SHF(L)-11H-46D1-51	SHF-19015	10180944602
SHF-14A-46	SHF-50033	10325030102
SHF-20D-46-02	SHF-50022	10325020102
SHF-20D-47-02	SHF-50041	10325030302
SHF-20D-57-02	SHF-50042	10325032902
SHF-20D-67-02	SHF-50043	10325039802
SHF-35B-47-04	SHF-50044	10325033602
SHF-35B-57-04	SHF-50045	10325035702
SHF-35B-59-04	SHF-50046	10325039902
SHF-35B-67-04	SHF-50027	10325031002
SHF-35B-69-04	SHF-50047	10325035802
SHF-35B-79-04	SHF-50048	10325033002



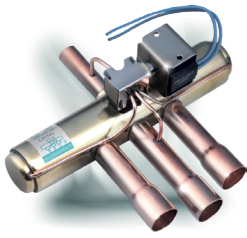

SANHUA SERIES SHF 4 Way Reversing Valve

APPENDIX 1

Conversion Table old/new Product Numbers

Valve Model	Product Number OLD reference	Product Number NEW reference (Multipack)
SHF-50A-79	SHF-50038	10325030002
SHF-50-911D2	SHF-50016	10325011602
SHF(L)-70-810	SHF-50017	10325030201
SHF(L)-70-810-01	SHF-50024	10325033101
SHF(L)-70-911	SHF-50049	10325038301
SHF(L)-70-911-01	SHF-50050	10325038301
SHF(L)-70-913-05	SHF-50052	10325039501
SHF(L)-70-913-03	SHF-50051	10325039701
SHF(L)-100-911	SHF-50053	10325037901
SHF(L)-100-911-01	SHF-50054	10325038001
SHF(L)-100-913	SHF-50055	10325033701
SHF(L)-100-913-01	SHF-50056	10325034701
SHF(L)-100-1012	SHF-50018	10325027101
SHF(L)-100-1012-01	SHF-50025	10325033201
SHF(L)-100-1013	SHF-50057	10325035501
SHF(L)-100-1013-01	SHF-50058	10325038901
SHF(L)-140-1113	SHF-50059	10325038101
SHF(L)-140-1213	SHF-50060	10325038601
SHF(L)-140-1214	SHF-50019	10180940401
SHF(L)-140-1313	SHF-50061	10325034101
SHF(L)-175-1217	SHF-50020	10325030401
SHF(L)-175-1317	SHF-50062	10325034001
SHF(L)-210-1321	SHF-50021	10325030501
SHF(L)-350-1721	SHF-50031	10325043301
SHF(L)-420-2125	SHF-50032	10325043601



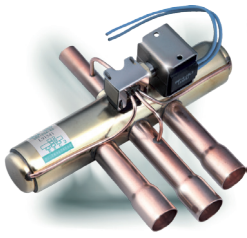

SANHUA SERIES SHF 4 Way Reversing Valve

APPENDIX 1

Conversion Table old/new Product Numbers

Coil Model	Product Number OLD reference	Product Number NEW reference (Multipack)
SQ-A25 22G-00 0001	SHF-56001	10805029102
SQ-A25 200-00 0001	SHF-56002	10805027002
SQ-A25 100-00 0001	SHF-56003	10805023602
SQ-A25 11A-00 0001	SHF-56004	10805150302
SQ-A25 024-00 0001	SHF-56005	10805227602
SQ-A25 26H-00 0001	SHF-56006	10805231902
SQ-A25 22G-00 0870	SHF-56024	10805240702
SQ-A25 11A-00 0840	SHF-56025	10805240802
SQ-A25 024-00 0161	SHF-56009	10805023002
SQ-A47 22G-00 0001	SHF-56028	10805263402
SQ-A47 220-00 0001	SHF-56029	10805273402
SQ-A47 11B-00 0001	SHF-56030	10805273302
SQ-A47 10A-00 0001	SHF-56031	10805268702
SQ-A47 024-00 0001	SHF-56032	10805263302
SQ-A47 26H-00 0001	SHF-56033	10805273502
SQ-D44 012-00 0001	SHF-56019	10805231802
SQ-D44 024-00 0001	SHF-56020	10805070102
SQ-A27 100-00 0001	SHF-56021	10805063202
SQ-A27 200-00 0001	SHF-56022	10805063802
SQ-A27 20K-00 0001	SHF-56027	10805222902
SQ-D27 012-00 0001	SHF-56023	10805069302

Accessory	Product Number OLD reference	Product Number NEW reference (Multipack)
SQ-000000-090028	SHF-56026	20805136302
SQ-000000-090029	SHF-56034	20805149202

